

BLACHA

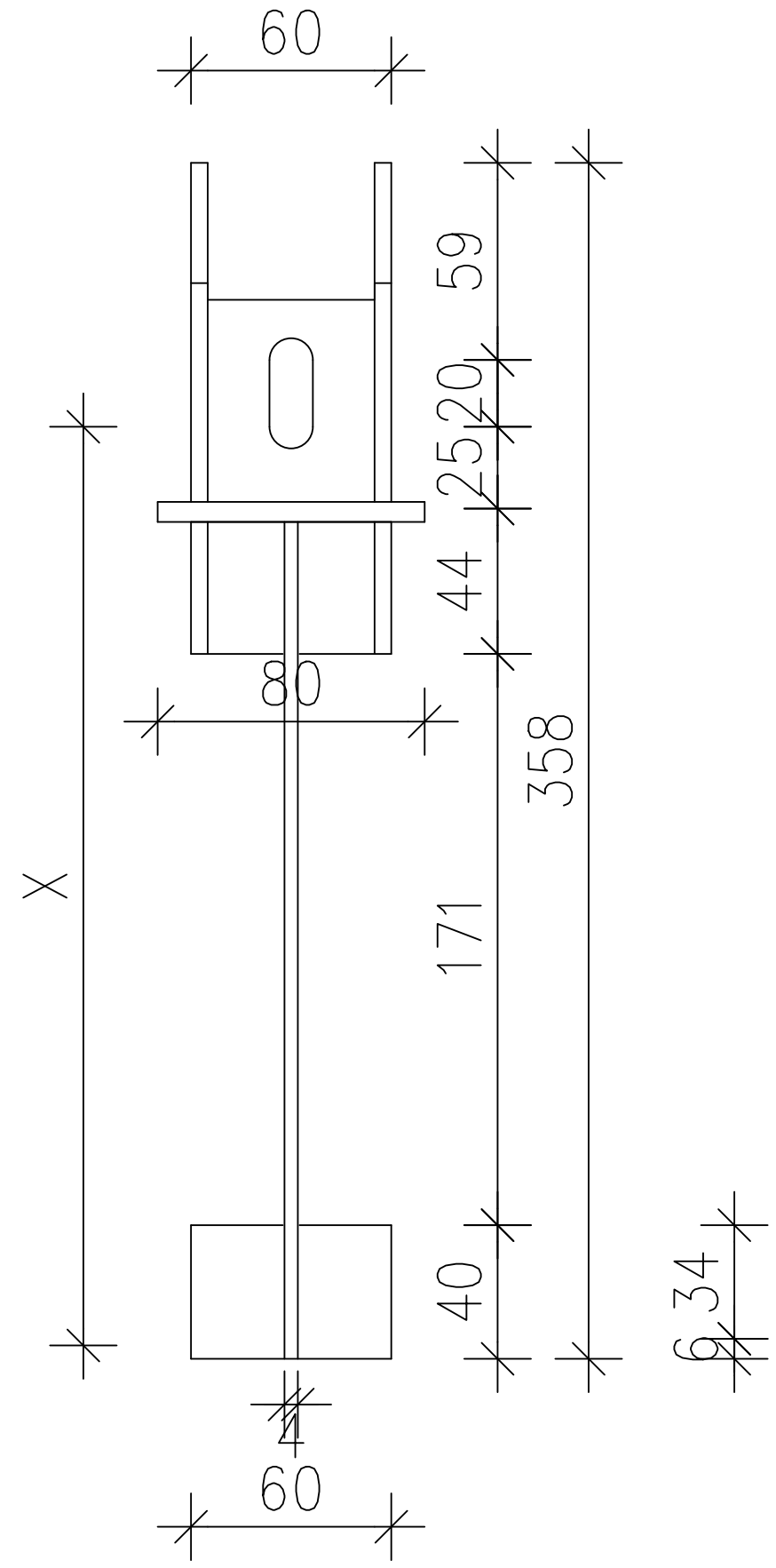
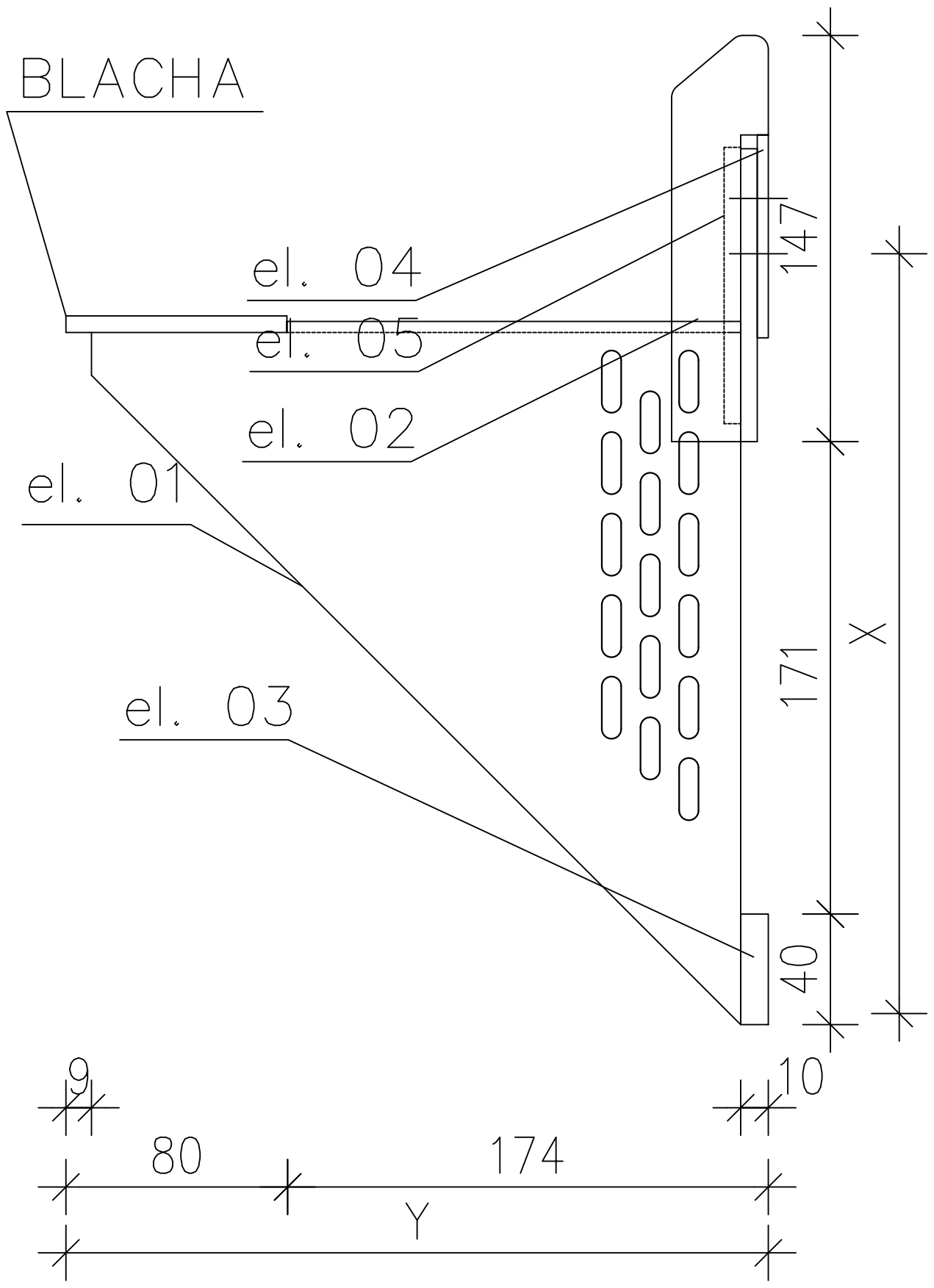

MATERIAL:

NORMA	EN	AISI/ASTM	DIN
NAZWA	1.4301	304	X5CrNi18-10

TOLERANCJE WYKONANIA - klasa „c” wg. ISO 2768-1
PRZEWODNOSC CIEPLNA A - 17 W/(mK)

Lp.	Nazwa/typ konsoli	Y [mm]	X [mm]
1.	KONSOLA AGS HK-K1-UT-3,5-235-250	235	250
2.	KONSOLA AGS HK-K1-UT-3,5-255-270	255	270
3.	KONSOLA AGS HK-K1-UT-3,5-275-290	275	290
4.	KONSOLA AGS HK-K1-UT-3,5-295-310	295	310
5.	KONSOLA AGS HK-K1-UT-3,5-315-330	315	330



Tytuł rys.	KONSOLA AGS HK-K1-UT-3,5-Y-X	Skala:	1:1
Nr rysunku:	[AGS HK-K1]-UT-3,5-Y-X	Rev.:	00
		DATA REV.:	01.06.2017